



DOORSLIJPMACHINE

QCUT 250 M

**De Qcut 250 M is een bijzonder gebruiksvriendelijk handmatige nat doorslijpmachine. Bij het openen van de machine vouwt de kap naar binnen, zodat de hele snijkamer gemakkelijk toegankelijk is. Het afgeronde venster zorgt ervoor dat de gebruiker een optimaal gezichtsveld heeft tijdens het snijproces.**

De koelsysteem is rechtstreeks geïntegreerd in het wielbeveiligingsdeksel. De grote, roestvrije tafel is voorzien van vervangbare slijtplaten. Transversale groeven zorgen voor een optimale opstelling van de klemmen (b.v. clamping vice 80).

## PRODUCTVOORDELEN

- | Handmatige verticale beweging
- | Ruime snijkamer
- | Opening aan de linker- en rechterkant voor eventuele lange delen
- | Grote tafel met uitwisselbare slijtplaten
- | Kap over volledige breedte voor optimale toegankelijkheid
- | Eenvoudige bediening
- | Alle onze klemsystemen zijn universeel te gebruiken met de Brillant
- | Huidige veiligheidsnorm met deurvergrendelingsstelsel
- | Gepoedercoate, solide aluminium behuizing

## KENMERKEN

### FINE DYNAMIC CUT-OFF

The manual cutting movement of the Y-axis is executed precisely and jerk-free via lever. Length and angle of the lever are adjustable. Further, the cutting depth can easily be adjusted by using a limiter.

### ILLUMINATION

Through the large rounded window, the cutting chamber is comfortably visible. For direct lighting, the Qcut 250 M can be equipped with a flexible LED light.

### SAFETY

The integrated standstill monitoring allows opening only when the cutting wheel is not rotating.

## PERFECT CUTTING - CUT-OFF WHEELS FROM QATM

Cutting is more reliable, safe and efficient when processed with the right ingredients: knowledge, care and the right choice of consumables and instruments.



## SNEL, KRACHTIG, FLEXIBEL - KLEMSYSTEMEN VAN QTOOLS

Onze innovatieve klemsystemen worden gebruikt om werkstukken veilig en nauwkeurig vast te klemmen om exact door te slijpen of te polijsten. Er is een uitgebreid pakket aan verschillende klemsystemen beschikbaar, die ontworpen werden voor specifieke toepassingen en werkstuk-afmetingen.

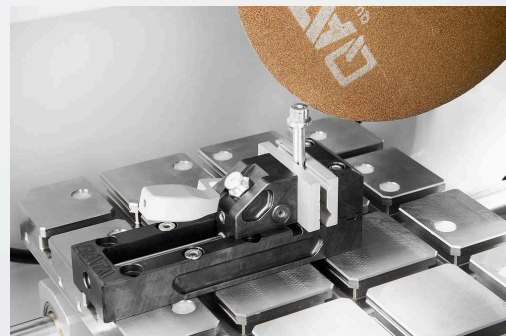

DOORSLIJPMACHINE QCUT 250 M

**TECHNISCHE GEGEVENS**

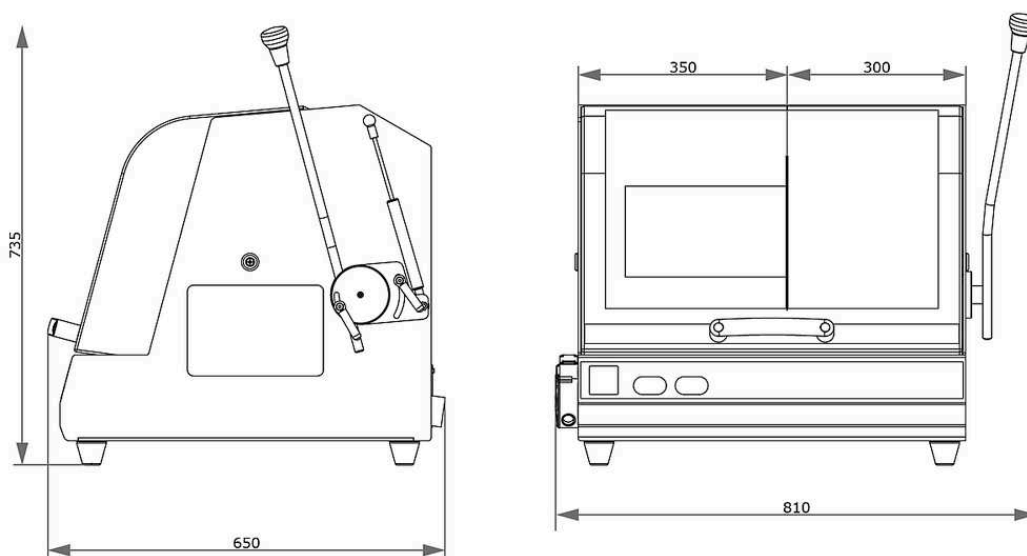

|   |  |
|---|--|
| <b>Doorslijpschijf</b>                        | up to $\varnothing$ 250 mm/10"                                 |
| <b>Max. cutting capacity</b>                  | $\varnothing$ 55 mm / $\varnothing$ 90 mm (up to 25 mm length) |
| <b>Afmeting flens voor slijpschijf</b>        | $\varnothing$ 32 mm  |
| <b>Y-as (verticale beweging)</b>              | 145 mm   |
| <b>Table WxD</b>                              | 350 x 288 mm stainless   |
| <b>T-slot</b>                                 | 12 mm  |
| <b>Aansluitvermogen</b>                       | 4.5 kVA  |
| <b>Vermogen aanrijving (hoofdaandrijving)</b> | 3 kW S6 40%  |
| <b>B x H x D</b>                              | 810 x 735 x 650 mm   |
| <b>Gewicht</b>                                | ~ 75 kg  |

[www.qatm.com/qcut-250-m](http://www.qatm.com/qcut-250-m)

## BESTELGEGEVENS

### BASIS UITRUSTING

#### MACHINE (ALLE POSITIES NOODZAKELIJK)

M1880000  Qcut 250 M (Brillant 200) Base machine

#### STROOMVOORZIENING (1 ITEM NOODZAKELIJK)

A1880000 Qcut 250 M power supply 400V/50Hz (3Ph/N/PE)

A1880001 Qcut 250 M power supply 480V/60Hz (3/PE)

A1880002 Qcut 250 M power supply 220V/60Hz (3/PE)

#### RECIRCULATION SYSTEM (1 ITEM REQUIRED)

A5800484  Recirculation Cooling System 45L 400V/50Hz (3Ph/PE) mobile, with insertion mechanism

A5800485  Recirculation Cooling System 45L 480V/60Hz (3Ph/PE) mobile, with insertion mechanism

A5800486  Recirculation Cooling System 45L 220V/60Hz (3Ph/PE) mobile, with insertion mechanism

A5800487  Recirculation Cooling System 45L 400V/50Hz (3Ph/PE) mobile, without folding wheels

A5800488  Recirculation Cooling System 45L 480V/60Hz (3Ph/PE) mobile, without folding wheels

A5800489  Recirculation Cooling System 45L 220V/60Hz (3Ph/PE) mobile, without folding wheels

### OPTIONS (TO BE ORDERED WITH MACHINE)

Z1820009  Centrifugal separator (machine mounted) 400V/50Hz/3 Ph

Z1820012  Centrifugal separator (machine mounted) 480V/60Hz/3 Ph

Z1820011



Centrifugal separator (machine mounted) 220V/60Hz/3 Ph

## PRECISION CLAMPING DEVICES, CLAMPING\_DEVICES, PRECISION\_CLAMPING\_DEVICES

|          |   |
|----------|---|
| Z1870035 | Sample holder L standard Ø 40 mm open, Clamping_devices, Precision_clamping_devices         |
| Z1870037 | Sample holder L standard Ø 40 mm closed, Clamping_devices, Precision_clamping_devices       |
| Z1870039 | Sample holder L Flex Ø 40 mm, Clamping_devices, Precision_clamping_devices                  |
| Z1870043 | Sample holder L parallel clamping vice open, Clamping_devices, Precision_clamping_devices   |
| Z1870041 | Sample holder L parallel clamping vice closed, Clamping_devices, Precision_clamping_devices |
| Z1870045 | Drop shape sample holder L Ø 40 mm, Clamping_devices, Precision_clamping_devices            |
| Z1870047 | Universal clamping vice L, Clamping_devices, Precision_clamping_devices                     |
| Z1870049 | Matrix clamping vice L, Clamping_devices, Precision_clamping_devices                        |
| Z1870054 | Mini vice L, Clamping_devices, Precision_clamping_devices                                   |
| Z1870056 | Double parallel vice L, Clamping_devices, Precision_clamping_devices                        |
| Z1870058 | Adaptor with ball joint L, Clamping_devices, Precision_clamping_devices                     |
| Z1870063 | Reduction ring Ø 30 mm, Clamping_devices, Precision_clamping_devices                        |
| Z1870071 | Reduction ring Ø 40 mm, Clamping_devices, Precision_clamping_devices                        |
| Z1870067 | Reduction ring 1", Clamping_devices, Precision_clamping_devices                             |
| Z1870066 | Reduction ring 1 1/4", Clamping_devices, Precision_clamping_devices                         |
| Z1870065 | Reduction ring 1 1/2", Clamping_devices, Precision_clamping_devices                         |
| Z1870069 | Manual chuck Ø 44 mm, Clamping_devices, Precision_clamping_devices                          |
| Z1870070 | Manual chuck Ø 56 mm, Clamping_devices, Precision_clamping_devices                          |

## VACUUM CLAMPING VICES, CLAMPING\_DEVICES, PRECISION\_CLAMPING\_DEVICES

|          |   |
|----------|---|
| Z1870028 | Vacuum sample holder, Clamping_devices, Precision_clamping_devices              |
| 01870288 | Vacuum holder (sacrificial plate), Clamping_devices, Precision_clamping_devices |

|          |  |
|----------|--|
| Z1304600 | Vacuum pump 230V/50Hz for vacuum sample holder, Clamping_devices, Precision_clamping_devices |
| Z1304634 | Vacuum pump 110V/60Hz for vacuum sample holder, Clamping_devices, Precision_clamping_devices |

## QUICK CLAMPING TOOLS, CLAMPING\_DEVICES

### QTOOL 60, CLAMPING\_DEVICES, QTOOL\_SERIES

|          |  |
|----------|--|
| Z2235200 | Qtool 60, Clamping_devices, Qtool_series   |
| 02235202 | Clamping jaw 32 mm - for Qtool 60, Clamping_devices, Qtool_series                |
| Z2235201 | Clamping jaws 60 mm - for Qtool 60, Clamping_devices, Qtool_series               |
| 02235212 | Clamping jaw 32 mm bevelled - for Qtool 60, Clamping_devices, Qtool_series       |
| 02235213 | Clamping jaw 32 mm cross prism - for Qtool 60, Clamping_devices, Qtool_series    |
| Z2235202 | Clamping jaws 60 mm slotted - for Qtool 60, Clamping_devices, Qtool_series       |
| Z2235203 | Clamping jaws 60 mm slotted prism - for Qtool 60, Clamping_devices, Qtool_series |

### QTOOL 80, CLAMPING\_DEVICES, QTOOL\_SERIES

|          |   |
|----------|---|
| Z2231203 | Qtool 80 - 100mm, Clamping_devices, Qtool_series                  |
| 02231243 | Clamping jaw 40 mm, Clamping_devices, Qtool_series                |
| Z2231215 | Clamping jaws 70 mm, Clamping_devices, Qtool_series               |
| 02231245 | Clamping jaw 40 mm bevelled, Clamping_devices, Qtool_series       |
| 02231246 | Clamping jaw 40 mm cross prism, Clamping_devices, Qtool_series    |
| Z2231216 | Clamping jaws 70 mm slotted, Clamping_devices, Qtool_series       |
| Z2231217 | Clamping jaws 70 mm slotted prism, Clamping_devices, Qtool_series |

### QTOOL 80 VARIO, CLAMPING\_DEVICES, QTOOL\_SERIES

|          |  |
|----------|--|
| Z2231200 | Qtool 80 Vario - 100 mm, Clamping_devices, Qtool_series                  |
| Z2231210 | Workpiece stop, Clamping_devices, Qtool_series                           |
| 02231200 | Clamping jaw, 40 mm - for Qtool 80 Vario, Clamping_devices, Qtool_series |
| Z2231211 | Clamping jaws, 70 mm, Clamping_devices, Qtool_series                     |
| 02231213 | Prism jaw, 40 mm, Clamping_devices, Qtool_series                         |
| 02231229 | Bevelled jaw, 40 mm, Clamping_devices, Qtool_series                      |

|          |   |
|----------|---|
| 02231230 | Cross prism jaw, 40 mm, Clamping_devices, Qtool_series        |
| Z2231212 | Round bar jaws, 70 mm slotted, Clamping_devices, Qtool_series |
| Z2231213 | Prism jaws, 70 mm slotted, Clamping_devices, Qtool_series     |
| Z2231214 | Clamping jaws, 70 mm slotted, Clamping_devices, Qtool_series  |

## EASY-CLAMPING PLATES, CLAMPING\_DEVICES, EASY\_CLAMPING\_PLATES

### ACCESSORIES FOR EASY-CLAMPING PLATES

|          |   |
|----------|---|
| Z2236032 | Easy adaption horizontal, Clamping_devices, Easy_clamping_plates    |
| Z2236033 | Easy adaption vertical, Clamping_devices, Easy_clamping_plates      |
| Z2236034 | Easy adaption Qtool 40 - 60, Clamping_devices, Easy_clamping_plates |
| Z2236038 | Multitower rotating plate, Clamping_devices, Easy_clamping_plates   |
| Z2236039 | Multitower, Clamping_devices, Easy_clamping_plates                  |
| Z2236040 | Swivel unit Qtool 40 - 60, Clamping_devices, Easy_clamping_plates   |
| Z2236036 | Easy-multifunctional plate, Clamping_devices, Easy_clamping_plates  |







## CLAMPING ACCESSORIES FOR ROTATING, SWIVELING AND SPECIAL APPLICATIONS, CLAMPING\_DEVICES, CLAMPING\_ACCESSORIES\_SPECIALS

|          |   |
|----------|---|
| Z2236041 | Swivel unit Qtool 60 - 80, Clamping_devices, Clamping_accessories_specials                |
| Z1304643 | Screw clamber with Easy-clamping plate M, Clamping_devices, Clamping_accessories_specials |
| Z1304636 | Expansion clamping device, Clamping_devices, Clamping_accessories_specials                |
| Z2236009 | Vertical clamp single, Clamping_devices, Clamping_accessories_specials                    |
| Z2236010 | Vertical clamp double, Clamping_devices, Clamping_accessories_specials                    |
| Z2234010 | Clamping system X-Clamp 3858, Clamping_devices, Clamping_accessories_specials             |

### CROSS VICES, CLAMPING\_DEVICES, CLAMPING\_ACCESSORIES\_SPECIALS

|          |  |
|----------|--|
| Z1340010 |  Cross vice 50 - 100, Clamping_devices, Clamping_accessories_specials |
|----------|--|

## UNIVERSAL VICES AND ACCESSORIES, CLAMPING\_DEVICES, UNIVERSAL\_VICES\_AND\_ACCESSORIES

|          |   |  |
|----------|---|--|
| 01350022 |   | Prism 120°, Clamping_devices, Universal_vices_and_accessories                                    |
| 01350023 |   | Prism slim, Clamping_devices, Universal_vices_and_accessories                                    |
| 01350024 |   | Prism 90°, Clamping_devices, Universal_vices_and_accessories                                     |
| 01350025 |   | Prism 90° high, Clamping_devices, Universal_vices_and_accessories                                |
| Z1350008 |    | Universal vice Piccolo 54, Clamping_devices, Universal_vices_and_accessories                     |
| Z1350010 |    | Suitcase set universal vice Piccolo 54, Clamping_devices, Universal_vices_and_accessories        |
| Z1350012 |    | Universal vice Piccolo 100, Clamping_devices, Universal_vices_and_accessories                    |
| Z1350002 |   | Universal vice Mono 61, Clamping_devices, Universal_vices_and_accessories                        |
| Z1350004 |  | Suitcase set universal vice Mono 61, Clamping_devices, Universal_vices_and_accessories           |
| Z1350011 |  | Universal vice Mono 132, Clamping_devices, Universal_vices_and_accessories                       |
| Z1350005 |   | Universal vice Duo, Clamping_devices, Universal_vices_and_accessories                            |
| Z1350006 |   | Chain vice set, Clamping_devices, Universal_vices_and_accessories                                |
| 92005796 |   | Longitudinal v-shoe, Clamping_devices, Universal_vices_and_accessories                           |
| 92005797 |   | Traverse v-shoe, Clamping_devices, Universal_vices_and_accessories                               |
| 92005799 |   | Longitudinal bridge, Clamping_devices, Universal_vices_and_accessories                           |
| 92005800 |   | Traverse bridge, Clamping_devices, Universal_vices_and_accessories                               |
| 92005798 |   | Standard clamping shoe, Clamping_devices, Universal_vices_and_accessories                        |
| Z1350007 |   | Height adapter 60mm Piccolo, Clamping_devices, Universal_vices_and_accessories                   |
| Z1350003 |   | Height adapter 74mm Mono, Clamping_devices, Universal_vices_and_accessories                      |
| 95003172 |   | Clamping arm extension Piccolo 54 and Mono 61, Clamping_devices, Universal_vices_and_accessories |
| Z1304591 |   | Fixing screw M6 x 25, Clamping_devices, Universal_vices_and_accessories                          |
| 95003169 |   | Fixing screw Piccolo M8 x 25, Clamping_devices, Universal_vices_and_accessories                  |

|          |  |
|----------|--|
| 95003170 | Fixing screw Piccolo M10 x 25, Clamping_devices, Universal_vices_and_accessories   |
| 95003168 | Fixing screw Mono M10 x 32, Clamping_devices, Universal_vices_and_accessories      |
| 91001157 | T-slot nut - stainless M6 x 8, Clamping_devices, Universal_vices_and_accessories   |
| 91001161 | T-slot nut - stainless M8 x 10, Clamping_devices, Universal_vices_and_accessories  |
| 91001159 | T-slot nut - stainless M8 x 12, Clamping_devices, Universal_vices_and_accessories  |
| 91001158 | T-slot nut - stainless M10 x 12, Clamping_devices, Universal_vices_and_accessories |